



PurePEX

**TECTITE**  
by  MOSACK GROUP

PureLink

# INSTRUCTION MANUAL

PEX-A, PEX-B, Push-To-Connect



# TABLE OF CONTENTS

## INSTALLATION MANUAL

<b>What Is PEX? Why Use PEX?</b> .....	<b>3</b>
<b>Tools</b> .....	<b>4-12</b>
<b>Fittings</b> .....	<b>13-16</b>
<b>PEX Pipe</b> .....	<b>17-18</b>
<b>Plumbing Systems</b> .....	<b>19-21</b>
<b>Manifolds</b> .....	<b>22-23</b>

## INSTALLATION MANUAL

## What Is PEX?

Cross-linked polyethylene (PEX) is a high-temperature, flexible, polymer pipe. Cross-linking technology was first developed in Europe and has since come into use around the world for a variety of applications. PEX has a 30-year history of successful use in the European market with extensive testing for durability and material performance. It was first introduced in North America in 1984 where it was primarily used for radiant floor heating. More recently, it has become used for domestic water distribution systems. It is approved for potable hot and cold water supply systems in all model plumbing and mechanical codes across the United States including California and Canada.

## Why Use PEX?

- **Easy to Install** - PEX pipe is joined with an easy to install "crimp" system; no solvent welding with messy chemicals, no chance of fire hazard possibilities due to soldering
- **Cost Effective** - When installed using Manifolds fewer fittings are needed to install PEX; meaning you save money in material and time. PEX pipe also costs less than copper pipe.
- **Availability of Pipe Sizes** - PEX pipe is available in a wide range of diameters.
- **Energy Efficiency** - PEX pipe minimizes heat transmission through the pipe wall.
- **Quiet** - When installed using Manifolds, PEX can be run in long lengths with smoother bends, meaning less water line noise. PEX also does not amplify sound as readily as copper pipe.
- **Water Conservation** - Well designed PEX plumbing systems can reduce the wait time for hot water to reach the fixture.
- **Environmentally Sound** - PEX is an inert material and does not contain volatile organic compounds (VOCs).
- **Installation Flexibility** - PEX systems can be installed in either a conventional "trunk and branch" system or a manifold "home-run" system. PEX is also great for adding fixtures off of your existing copper or CPVC system.
- **Corrosion Resistant** - Because of PEX's smooth inner walls, minerals do not build up as fast as with copper pipe. It is also more resistant to the harmful effects of abrasive chemicals such as chlorine.
- **Freeze Resistant** - While freezing conditions often cause copper and CPVC pipe to break or burst, causing thousands of dollars in water damage, PEX pipe will expand several times its original size without damage. However, it is recommended that you follow all codes regarding water line freeze prevention.

### Features:

- Tough
- Flexible
- Less expensive than other plumbing materials
- Copper tube size dimensions (CTS)
- Available in white, red, or blue

### PEX-B Standards / Certifications:

- PEX 5106 - SDR 9
- cNSFus-pw
- cUPC
- Meets ASTM F876/F877
- ANSI/NSF 61 & 14
- CSA B137.5

### PEX-A Standards / Certifications:

- PEX 5106 - SDR 9
- cNSFus-pw
- cUPC
- Meets or exceeds: ASTM F876/F877/F1807/F1960/F2023/F2080/F2155
- Meets ANSI/NSF 61 & 14
- Meets CSA B137.9

### Pressure & Temperature:

- 160 psi @ 73° F, 100 psi @ 180° F



### HOW TO USE

## Crimp Tools

69PTKH0014C - 1/2" & 3/4"  
69PTKH0015K - 3/8"-1"



1. Cut pipe end squarely. Check for and remove any burrs.



2. Slide crimp ring over end of pipe. Insert fitting into end of pipe until it stops. Position the crimp ring 1/8" to 1/4" from the end of the pipe and over the ribs of the fitting.

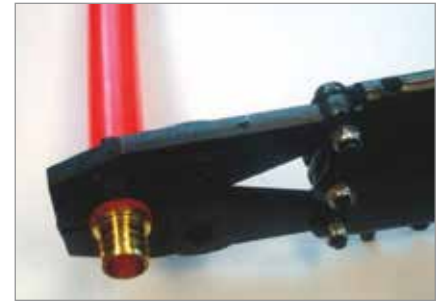

3. Place the crimping end of tool around the crimp ring and press the handles together.



4. Check for proper crimp with the Go/ No-Go gauge.

Pure PEX Crimp Rings		
WPXCR38	3/8"	100 Pack
WPXCR12	1/2"	100 Pack
WPXCR34	3/4"	100 Pack
WPXCR1	1"	50 Pack

Pure PEX PRO Crimp Rings		
WPXCR12LT	1/2"	100 Pack
WPXCR34LT	3/4"	100 Pack

### To remove and replace crimp heads: For 69PTKH0015K only (Heads cannot be replaced on all other Pure PEX crimp tools)



1. With the handles fully open, press side release spring upward until the hook is above the jaw pin.



2. Slide jaw out of position and remove.



3. With the side release spring pressed upward, slide new jaw into place and release the spring.

If you have a 69PTKH0015K that does not have spring loaded jaws, but jaws that are secured with screws, simply loosen the screws located at the center of the jaws. Remove the jaws and slide the jaws you need into place. Replace the screws at the center of the jaws and tighten.

HOW TO USE

# Angle Crimp Tool



69PTKANG143 - 1/2"  
69PTKANG144 - 3/4"



1. Cut pipe end squarely. Check for and remove any burrs.



2. Slide crimp ring over end of pipe. Insert fitting into end of pipe until it stops. Position the crimp ring 1/8" to 1/4" from the end of the pipe and over the ribs of the fitting.

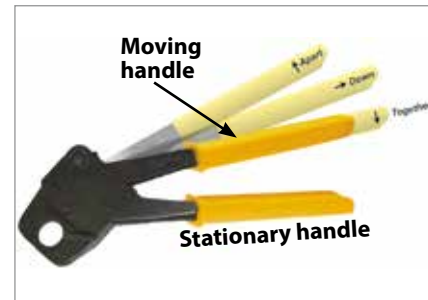

3. To open the jaws: In a continuous motion, pull the moving handle apart, down, then back towards the stationary handle.



4. Place the crimping end of tool around the crimp ring. Push the handles together firmly until the jaws are completely closed. Repeat step 3 to release the tool from the crimped ring.



5. Check for proper crimp with the Go/ No-Go gauge. Crimped ring should slide into the "Go" slot. Pressure test the PEX pipe and inspect before burying or normal use.

Pure PEX Crimp Rings		
WPXCR38	3/8"	100 Pack
WPXCR12	1/2"	100 Pack
WPXCR34	3/4"	100 Pack
WPXCR1	1"	50 Pack

Pure PEX PRO Crimp Rings		
WPXCR12LT	1/2"	100 Pack
WPXCR34LT	3/4"	100 Pack

HOW TO USE

69PTKD0009

### Crimp Ring Removal Tool



1. Set dial or thumb slide on tool to desired ring cutting size.

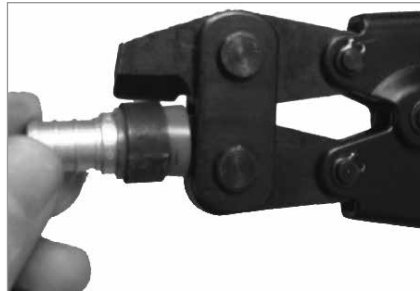

2. Cut PEX pipe close to fitting and insert small jaw inside fitting and compress handle, forcing cutter through crimp ring.



3. Reposition cutter to other side of crimp ring and compress handle forcing the crimp ring open.

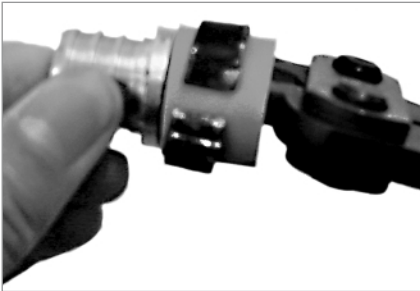

4. Remove PEX ring from pipe.

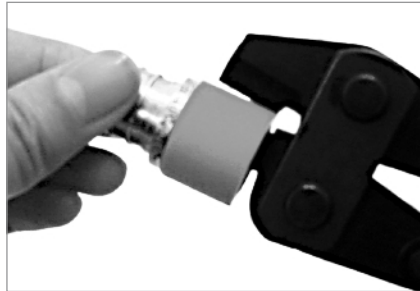

5. Reinsert removal tool into fitting and fully close the handles, forcing the cutting jaw into the PEX pipe.

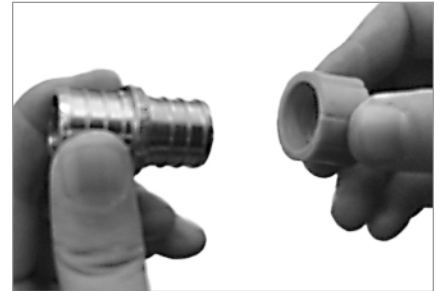

6. Repeat in several positions to free PEX pipe for removal.

HOW TO USE

**Go/No-Go Gauge**

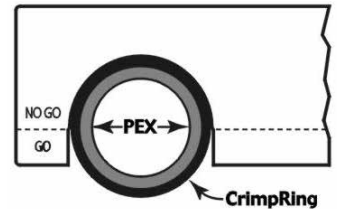
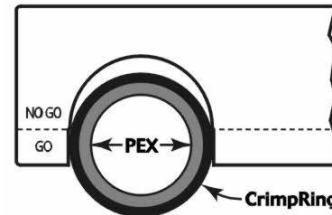
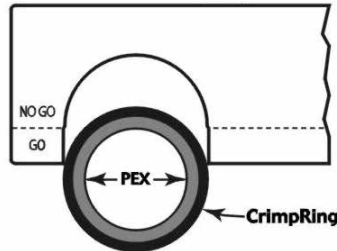

1. Slide the correct slot on the gauge around the crimped ring.

2. If the ring does not fit into the slot at all, then the crimp is a "No-Go". Adjust the crimping force on the tool and re-crimp the ring.

3. If the ring slides into the slot and stops in the "Go" range, then the crimp is good.

4. If the ring slides all the way into the slot, then the crimp ring is compressed too small and is a "No-Go". Remove the ring and adjust the crimping force on the tool.

**Crimp Rings vs. Pinch Clamps vs. Crimp Sleeves vs. Pros**



**Crimp Ring**

- Copper material
- Use with brass or poly alloy fittings
- Gauge available to check for proper crimp



**Pro Crimp Ring**

- Copper material with plastic top
- Use with brass or poly alloy fittings
- Allows for hands free fastening
- Secures crimp ring position on pipe
- Guarantees proper ring placement



**Crimp Sleeve**

- Stainless Steel material
- Use with brass or poly alloy fittings
- One tool can clamp 1/2" or 3/4" sleeves
- Reduced equipment cost
- Secures crimp sleeve position on pipe



**Pinch Clamp**

- Stainless Steel material
- Use with brass or poly alloy fittings
- One tool can clamp several ring sizes
- Reduced equipment cost



**Pro Pinch Clamp**

- Stainless Steel material with plastic tab
- Use with brass or poly alloy fittings
- One tool can clamp several ring sizes
- Allows for hands free fastening
- Secures crimp ring position on pipe
- Guarantees proper ring placement

*Rings, clamps, and sleeves may be buried but should be wrapped with pipe insulation prior to burying.*

### HOW TO USE

69PTKH0014SS

# Stainless Steel Crimp Sleeve Combo Tool



1. Cut PEX pipe square, leaving a clean, even edge. Remove any burrs.



2. Slip sleeve on tube and position fitting into tube.



3. Set tool 1/8 in. to 1/4 in. from end of tube. Crimp sleeve with tool.



4. Use the Go/No-Go Gauge to ensure a leakproof joint.

Pure PEX Stainless Steel Crimp Sleeves		
WPXSS12	1/2"	100 Pack
WPXSS34	3/4"	50 Pack
WPXSS1	1"	25 Pack

*Use with Stainless Steel Crimp Sleeves ONLY.  
Do not use with Zurn® Qickclamp™.*



HOW TO USE

# Quick Pinch Clamp Tool

69PTKG1096



1. Cut PEX pipe square, leaving a clean, even edge. Remove any burrs.



2. Slip PEX pinch clamp over pipe and insert fitting. Place pinch clamp 1/8" below edge of pipe.



3. Place PEX pinch clamp nub between tool jaws and ratchet the clamp until the PEX Pinch Clamp Tool auto-releases. This action will assure that the PEX pinch clamp is fully engaged.



4. Pressure test the PEX pipe and inspect before burying or normal use. If there are any signs of leaks, repeat the total procedure.

Pure PEX Pinch Clamps		
WPXPC38	3/8"	100 Pack
WPXPC12	1/2"	100 Pack
WPXPC34	3/4"	100 Pack
WPXPC1	1"	25 Pack

Pure PEX Pro Pinch Clamps		
WPXPRO12	1/2"	100 Pack
WPXPRO34	3/4"	100 Pack

For use with Pure PEX, Watts®, Murray®, and Oetiker® PEX cinch clamps.  
Do not use with Zurn® Qickclamp™ PEX crimp rings.

### HOW TO USE

69PTBJ0010C

# One Hand Pinch Clamp Fastening Tool



1. Cut PEX pipe square, leaving a clean, even edge. Remove any burrs.



2. Slip PEX pinch clamp over pipe and insert fitting. Place pinch clamp 1/8" below edge of pipe.

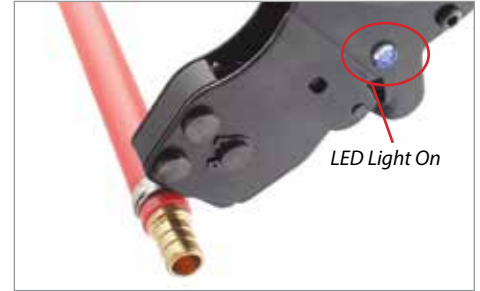

3. Place pinch clamp nub between tool jaws and ratchet the clamp (approximately seven times) until the LED light comes on. This will assure that the pinch clamp is fully engaged.



4. To release the Pinch Tool, rotate the release lever on the side. It is very important to complete the pinch process before releasing the tool.

Pure PEX Pinch Clamps		
WPXPC38	3/8"	100 Pack
WPXPC12	1/2"	100 Pack
WPXPC34	3/4"	100 Pack
WPXPC1	1"	25 Pack

Pure PEX Pro Pinch Clamps		
WPXPRO12	1/2"	100 Pack
WPXPRO34	3/4"	100 Pack

LED Battery (Can be purchased at any local retailer)		
CR927	Lithium Cell (3V)	1

The LED light may not turn on after more than 7 ratchets when installing some 1 in. pinch clamps. Don't over clamp! Check with specification of pinch clamp manufacturer.

For use with Pure PEX, Watts®, Murray®, and Oetiker® PEX pinch clamps.

**Do not use with Zurn® Qickclamp™.** Do not use the fastening tool to remove pinch clamps.

INSTRUCTION SHEET

69PTKPCRR

# Pinch Clamp Removal Tool



1. Slide the pinch clamp nub into the removal tool slot. If the nub is too large to fit into the tool, use the clamp tool to pinch the clamp one more time.



2. Twist the nub with the tool until the clamp breaks or loosens.



3. Remove the tool from the clamp, then remove the clamp from the pipe.

Tool head can be removed and used on a standard 1/2" socket wrench.

### HOW TO USE

EPXTOOLKIT, EPXTOOL

## Expansion PEX Tool



1. Lightly grease the cone of the expansion tool.



2. Attach the expansion head onto the expansion tool.



3. Cut pipe squarely.



4. Place an expansion sleeve onto the end of the pipe.



5. Open the tool handles fully and gently insert the tool head into pipe until it stops.



6. Expand by pressing the tool handles together. Open handles, rotate tool and repeat. Refer to the chart below for the recommended number of expansions per pipe size.



7. Expansion is complete when the pipe and sleeve are against the shoulder of the tool head.

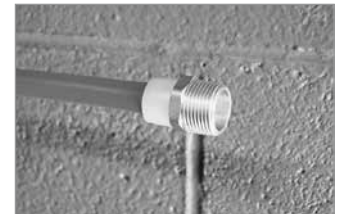

8. Immediately remove the tool from the pipe and sleeve. Insert the fitting until its shoulder touches the sleeve end. Pipe may take up to two minutes to fully seal fitting.

Pipe Size	Number of Expansions
1/2"	3-4
3/4"	7-9
1"	12-14



Pure Link Expansion PEX Sleeves		
WPXS12	1/2"	100 Pack
WPXS34	3/4"	50 Pack
WPXS1	1"	25 Pack

Compatible with Uponor (Wirsbo) ProPEX™.  
Use with PEX-A pipe only.

HOW TO INSTALL

**PEX connections**

**Crimp ring connection:**

1. Fitting shoulder.
2. Pipe is cut squarely and stops at fitting shoulder.
3. Position the ring or clamp 1/8" - 1/4" from the end of the pipe, over the two ends ribs of the fitting.
4. The ring or clamp is evenly compressed over the pipe.
5. The PEX material is uniformly compressed between the ribs, resulting in a leak-free joint.

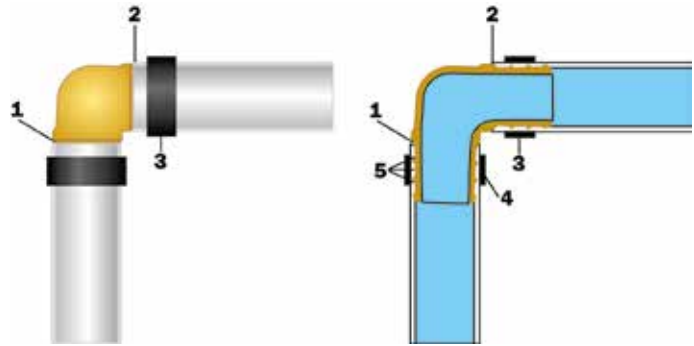

**Pinch clamp connection:**

1. Keep all components clean until ready for use. Dirt, water, or other contaminants on mating contact surfaces of the clamp, pipe, or fitting can result in an inferior assembly. When in doubt, wipe clean before assembly.
2. Cut PEX pipe squarely and remove burrs.
3. Slide ring or clamp over end of PEX pipe and pipe over fitting to the fitting shoulder. Position ring 1/8"-1/4" from pipe end, over the two ribs closest to the end of the fitting.
4. Crimp according to tool directions.
5. Maximum root gap in nub of clamp after crimping is 0.08". If the gap exceeds this limit, the tool should be recalibrated. The existing joint should be reclamped with a new clamp.

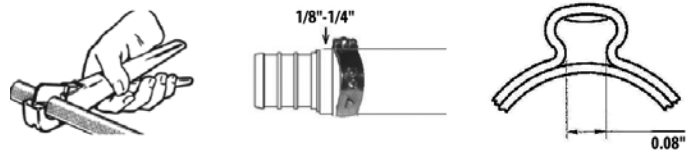

All Pure PEX tools are pre-calibrated from the factory to perform up to 10,000 fastens.

If you feel your tool needs calibrating to perform a correct fasten, contact customer service for assistance.

*Rings, clamps, and sleeves may be buried but should be wrapped with pipe insulation prior to burying.*

## OVERVIEW

### Brass PEX Fittings

Pure PEX Brass Fittings are used for making junctions or directional changes with PEX pipe constructed potable water systems.



All Pure PEX Brass Fittings have barb ends unless otherwise noted.

All Pure PEX Fittings comply with the U.S. Safe Water Drinking Act (SWDA) and the 2011 U.S. Reduction of Lead in Drinking Water Act by containing equal to or less than 0.25% lead.

#### Specifications:

Use Pure PEX Brass Fittings with Pure PEX pipe and fasten to pipe using Pure PEX Crimp Rings, Pure PEX Pinch Clamps, or Pure PEX Crimp Sleeves with Pure PEX Tools. Brass PEX fittings can be used with Pure PEX-A or PEX-B pipe. Brass Expansion PEX fittings can only be used with PEX-A pipe. Follow all instructions included with Pure PEX tools, fittings, and fasteners.

#### Approvals:

- ASTM F877 and F1807 Conformance - Third Party Certified
- NSF 14 and 61
- IAPMO
- CSA B137.5

### Poly Alloy PEX Fittings

Pure PEX Poly Alloy Fittings are used for making junctions or directional changes with PEX pipe constructed potable water systems. Poly Alloy fittings are well-suited for hard water systems.



Pure PEX Poly Alloy Fittings are a polysulfone/polyphenylsulfone blended polymer.

All Pure PEX Poly Alloy Fittings have barb ends unless otherwise noted.

#### Specifications:

Use Pure PEX Poly Alloy Fittings with Pure PEX pipe and fasten to pipe using Pure PEX Crimp Rings or Pure PEX Pinch Clamps, or Pure PEX Crimp Sleeves with Pure PEX Tools. Poly Alloy PEX fittings can be used with Pure PEX-A or PEX-B pipe. Poly Alloy Expansion PEX fittings can only be used with PEX-A pipe. Follow all instructions included with Pure PEX tools, fittings, and fasteners. DO NOT overtighten threaded fittings.

#### Approvals:

- ASTM F876/F877/F2159
- IAPMO
- cUPC
- cNSF<sup>us</sup> pw-G, NSF<sup>us</sup> pw
- CSA B137.5
- ANSI/NSF 61 & 14

OVERVIEW

# Expansion PEX Fittings

Pure Link Expansion PEX Fittings (brass and poly alloy) are used for making junctions or directional changes with PEX-A pipe constructed potable water systems.

All Pure Link Expansion PEX Fittings have barb ends unless otherwise noted.

All Pure Link Expansion PEX Fittings comply with the U.S. Safe Water Drinking Act (SWDA) and the 2011 U.S. Reduction of Lead in Drinking Water Act by containing equal to or less than 0.25% lead.

**Specifications:**

Use Pure Link Expansion PEX Fittings with Pure PEX-A pipe and fasten to pipe using Pure Link Expansion Sleeves. Brass Expansion PEX fittings can only be used with PEX-A pipe. Follow all instructions included with Pure Link tools, fittings, and fasteners. Compatible with Uponor (Wirsbo) ProPEX™. (ProPEX™ is a trademark of Uponor [Wirsbo].)

**Approvals:**

Expansion PEX Brass Fittings

- ASTM F877 and F1807 Conformance - Third Party Certified
- IAPMO
- NSF 14 and 61
- CSA B137.5

Expansion PEX Poly Alloy Fittings

- ASTM F876/F877/F2023/F1960
- NSF-pw (Standards 14 & 61)
- IAPMO
- CSA B137.5

**PEX-A Brass Crimp Fittings**

**Friction Loss - Equivalent Feet of PEX Pipe**

Size	Coupling	Elbow	Tee Run	Tee Branch
3/8"	2.9	9.2	2.9	9.4
1/2"	2.0	9.4	2.2	10.4
3/4"	0.6	9.4	1.9	8.9
1"	1.3	10.0	2.3	11.0

**PEX-A Poly Alloy Crimp Fittings**

**Friction Loss - Equivalent Feet of PEX Pipe**

Size	Coupling	Elbow	Tee Run	Tee Branch
1/2"	7.1	16.5	7.2	17.9
3/4"	4.8	17.4	6.6	17.7
1"	4.5	18.0	6.0	17.0

**Pressure Drop  
PSI per Foot of PEX Pipe**

gpm	3/8"	1/2"	3/4"	1"
1	0.070	0.016		
1.5	0.149	0.034		
2.2	0.303	0.069		
2.5	0.385	0.087		
3	0.539	0.122	0.023	
3.5	0.717	0.162	0.030	
4		0.208	0.039	
5		0.314	0.059	
6		0.440	0.082	0.024
7		0.586	0.109	0.032
8			0.140	0.041
9			0.174	0.051
10			0.211	0.062
11			0.252	0.074
12			0.296	0.087
13			0.343	0.101
14				0.116
15				0.148
16				0.184
17				0.224
18				0.267
	= 8 fps per size pipe			

NOTE: Maximum flow for each size based on 12 fps velocity. PSI x 2.307 = head loss.

### OVERVIEW

# Brass Push To Connect Fittings

Tectite by Mosack Group Push-To-Connect fittings are the fastest, cleanest and simplest way to join any combination of copper, CPVC, PE-RT and PEX pipe without the use of tools, solder, open flame or glue.

Simply insert the pipe to allow the high-strength stainless steel teeth to grip the pipe securely against the specially designed O-ring. Fitting removal and reuse is just as simple using a simple demount clip (sold separately). After assembly, fittings may be rotated for simpler installation in tight spaces.

All Tectite by Mosack Group fittings are approved for use in both potable water and hydronic heating piping systems.

#### Features:

- Constructed of lead free dezincification resistant (DZR) brass for superior reliability
- Push-to-connect joints require no heat, solder, solvents or tools
- Push-to-connect design allows for a simple and fast installation on any combination of copper, PEX, CPVC or PE-RT pipe
- Corrosion resistant for greater longevity
- Lifetime warranty on most fittings. Refer to The Mosack Group, Inc. Warranty on [www.MosackGroup.com](http://www.MosackGroup.com) for item specific information.

#### Specifications:

- Maximum Working Pressure: 200 psi
- Temperature Range: 32°-250° F
- Approved for behind-the-wall with no access and burial
- Ideal for potable water and hydronic heating applications

#### Approvals:

- NSF 61
- ASSE1061
- IAPMO
- Meets UPC, IPC, and cUPC standard requirements

## Push Fittings

### How to connect:

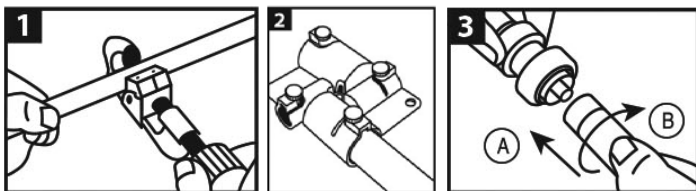

1. Cut pipe.

2. Mark the insertion depth using the depth gauge (sold separately).

3. Push pipe (A) and twist (B) into fitting until fitting edge meets insertion line.

### How to disconnect:

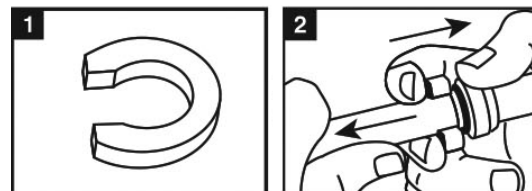

1. Removal tool (sold separately).

2. Place tool around pipe next to fitting. Press tool toward fitting while pulling pipe from fitting.

The use of pipe inserts for plastic pipe connections with Tectite by Mosack Group Push Fittings is **recommended** in standard residential plumbing (hot and cold water) installations. Pipe inserts are included with all Tectite by Mosack Group Push Fittings.

The use of pipe inserts for plastic pipe connections with Tectite by Mosack Group Push Fittings is **required** in all heating installations. Pipe inserts are included with all Tectite by Mosack Group Push Fittings.



## PEX-B Pipe

PEX-B pipe is cross-linked, high-density polyethylene. It's available in white, red, or blue colors for easy identification of hot and cold water lines.

Pure PEX pipe is type PEX-B (PE-Xb, PEXb). The silane method, also called the "moisture cure" method, results in PEX-B. In this method, cross-linking is performed in a secondary post-extrusion process, producing cross-links between a cross-linking agent. The process is accelerated with heat and moisture. The cross-linked bonds are formed through silanol condensation between two grafted vinyltrimethoxysilane (VTMS) units, connecting the polyethylene chains with C-C-Si-O-Si-C-C bridges.<sup>1</sup>

PEX pipe is for use in hot and cold potable water distribution systems as well as hydronic radiant heating systems. PEX pipe can also be used in "continuously recirculating" plumbing systems up to 140°F while maintaining chlorine resistance.



### Features:

- Tough
- Flexible
- Less expensive than other plumbing materials
- Copper tube size dimensions (CTS)
- Available in white, red, or blue
- 25-Year warranty

### Standards / Certifications:

- PEX 5106 - SDR 9
- Meets ASTM F876/F877
- cNSFus-pw
- ANSI/NSF Standards 61 & 14
- cUPC
- CSA B137.5

### Pressure & Temperature:

- 160 psi @ 73° F, 100 psi @ 180° F

### Installation:

To cut PEX pipe, use a PEX pipe cutter and cut at a 90° angle. Clear the cut end of any burrs or debris. PEX pipe can be run through holes drilled into the center of studs or by using straps and hangers. Bend supports can be used to make bends and angles instead of having to cut the pipe and use fittings. A variety of barb fittings or push type fittings can be used with PEX pipe. Do not expose PEX pipe to direct sunlight.

**It is recommended to insulate hot water lines with standard foam polyethylene pipe insulation to prevent heat loss. If installing in an area that experiences harsh winters, it's recommended to insulate both hot and cold water lines to prevent freezing.**

<sup>1</sup> [http://en.wikipedia.org/wiki/Cross-linked\\_polyethylene](http://en.wikipedia.org/wiki/Cross-linked_polyethylene)

Fluid Capacity of Pure PEX Pipe	
Nominal Size	Gallons/100' of PEX Pipe
3/8"	0.53
1/2"	0.96
3/4"	1.40
1"	3.10

### Expansion PEX Pipe

PEX-A pipe is cross-linked, high-density polyethylene. All Pure Link Expansion PEX is opaque in color and is available with black, red, or blue print lines for easy identification of hot, cold, and main water lines. Pure Link uses the high-pressure peroxide method of cross-linking which is also known as PEX-A.

Pure Link Expansion PEX pipe is produced using the high-pressure peroxide method for crosslinked polyethylene (PEXa) in accordance with ASTM F876, F877, CSA B137.5 and PPI TR-3, and is certified to NSF 14/61 standards. Pure Link Expansion PEX pipe also meets the requirements of ASTM F2023 for chlorine resistance. Pure Link Expansion PEX pipe is manufactured using a quality management system which has been certified to the latest version of ISO 9001

Use of Pure Link Expansion PEX pipe in heating systems requires corrosion protection and/or isolation by using a heat exchanger or non-ferrous components throughout the system.

#### Features:

- Superior flexibility allows for fewer joints, thus reducing leak points
- Expandable and allows for “full flow”
- Less coil memory than traditional PEX pipe and resists the urge to remain coiled
- Compatible with both expansion and crimp, clamp or sleeve methods of joining
- Heat-repairable if kinked during installation, thus further eliminating additional repair connections
- Shape memory inherent in PEX-A pipe results in the shrinking of expanded pipe to normal size, creating strong, durable, and reliable ASTM F1960 fitting connections
- Maximum cross-linking increases flexibility and resistance to cracking
- Copper tube size dimensions (CTS)
- Available in white, red, or blue colors
- Approved for use with brass and poly alloy crimp fittings (ASTM F1960 and ASTM 1807)
- 25-Year warranty

#### Standards / Certifications:

- PEX 5106 - SDR 9
- Meets or exceeds: ASTM F876/F877/F1807/F1960/F2023/F2080/F2155
- cNSFus-pw
- Meets ANSI/NSF 61 & 14
- cUPC
- Meets CSA B137.9

#### Maximum Pressures & Temperatures:

- 160 psi @ 73.4° F (1055 kPa @ 23° C), 100 psi @ 180° F (690 kPa @ 82.2° C), 80 psi @ 200° F (550 kPa @ 93.3° C)
- Design factor 0.50 (per ASTM F876, CSA B137.5)

#### Installation:

Cut PEX pipe at a 90° angle using a PEX pipe cutter. Clear the cut end of any burrs or debris. PEX pipe can be run through holes drilled into the center of studs or by using straps and hangers. Bend supports can be used to make bends and angles instead of having to cut the pipe and use fittings. A variety of barb insert fittings or push type fittings can be used with PEX pipe. **DO NOT expose PEX pipe to direct sunlight.** It is recommended to insulate hot water lines with standard foam polyethylene pipe insulation to prevent heat loss. If installing in an area that experiences harsh winters, it's recommended to insulate both hot and cold water lines to prevent freezing.

Compatible with Uponor (Wirsbo) ProPEX™. (ProPEX™ is a trademark of Uponor [Wirsbo].)

The maximum temperature and pressure ratings of Pure Link Expansion PEX pipe are in accordance to ASTM F876, CSA B137.5 and PPI TR-3. The designer shall determine the actual conditions and apply the appropriate and additional design factors as required for any particular project. The temperature and pressure ratings apply to the application of Pure Link Expansion PEX pipe for conveying heating and cooling water at the 2.0 safety factor on allowable working pressure according to ASTM and CSA. According to the Pure Link Expansion PEX warranty, the warranty period of 25 years is for operating conditions at or below 180°F (82.2°C) in permitted applications when the handling, use, installation and maintenance continually complies with all Pure Link Expansion PEX technical guidelines.

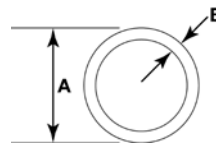

Article No.	Nom. Size in	Avg OD A in (mm)	Min. Wall Thickness B in (mm)	Weight lb/ft (kg/m)	Capacity gal/ft (l/m)
WEPPBXXX12 WEPPRXXX12 WEPPWXXX12	1/2	0.625 (15.88)	0.070 (1.78)	0.06 (0.08)	0.0098 (0.1222)
WEPPBXXX34 WEPPRXXX34 WEPPWXXX34	3/4	0.875 (22.22)	0.097 (2.47)	0.10 (0.15)	0.0189 (0.2356)
WEPPBXXX1 WEPPRXXX1 WEPPWXXX1	1	1.125 (28.58)	0.125 (3.18)	0.17 (0.26)	0.0316 (0.3939)

## Do Not Use with PEX

Liquid-based leak detectors, adhesive tape, pipe dope, linseed oil, threading compound, putty, mineral oil, petroleum products, metal pipe hangers.

## Leave Excess Pipe

Leave extra pipe at the beginning and end of runs to simplify connection to manifolds and end points and to make connections without straining the pipe or connection. Immediate connection to a manifold or transition fittings and then making the run reduces the chance of cutting pipe too short.

## Identify Pipe Runs

Clearly and permanently mark each run at each end to identify the fixture it supplies (hot or cold water, bathroom sink, kitchen sink, basement toilet, etc). Do not apply adhesive labels to PEX pipe.

## Thermal Expansion

Because PEX tube expands and contracts at about 1" per 100' of pipe for every 10°F change in temperature you must allow for expansion and contraction in long runs. This can be accomplished with an offset or expansion loop.

## PEX and Concrete

Pipe installed within or under concrete slabs should be continuous lengths of PEX tube. Do not install fittings beneath concrete.

## Minimum Bend Radius

Do not bend tube too tightly. The minimum recommended bend radius is six times the tube size (i.e. ½" tube = 3" bend radius). When making a 90° turn, use bend supports.

## Pipe Hangers

Plastic hangers are recommended for use with Pure PEX pipe. To prevent noise transfer, only use hangers that keep the tube off of the nailing surface. Hangers should be used every 32" on horizontal runs and every 4' on vertical runs. Allow the tube to dip between hangers and never over tighten. To prevent stress on the crimp joints, always support pipe before and after the fitting.



## Tube Through Studs

Grommets should be used when running pipe through studs to prevent damage and reduce noise transfer. Pipe that is run within 2" of a stud nailing surface must be protected with a metal stud guard.



## Stubouts

A copper stubout may be used to exit a branch from a wall. If a stubout is used, take care not to rotate the connection when cutting the end off. Always check local codes on the use of copper stubouts.



## Trenching

If PEX pipe is placed in a trench, leave sufficient excess to allow for expansion and contraction when temperatures change in the pipe.

## PEX Pipe at Expansion Joints

Add a protective layer of insulation or place the pipe into the material underneath if installing PEX pipe under expansion joints.

## PEX Pipe and Water Heater Installation

PEX water lines must not come within 18 in. of the water heater, nor less than 6 in. to the side or less than 12 in. above the water heater metal vent.

## Temperature and Sunlight

Keep PEX pipe away from extreme temperatures - 12" away from recessed lighting and 6" away from gas vents. Also, keep away from attics, crawl spaces, outside walls, or insulate per plumbing codes. Keep out of direct sunlight.

## Excessive Pressure and Temperature

Pure PEX and Pure Link pipe is rated up to 160 psi at 73° F or 100 psi at 180° F. Exceeding these ratings will void the warranty.

## Excessive Heat

Soldering - Do not solder near PEX pipe.

Water Heaters and Boilers - Use a minimum of 18" of metal pipe to transition between PEX pipe and the water heater/boiler.

## Freeze Protection

PEX is resistant to freeze damage, but freeze protection is recommended that is typical to the area where installing. Fittings and connections can be damaged if the plumbing system freezes.

## Thawing a Frozen System

Do not send electrical currents through a PEX plumbing system. Do not use an open flame to thaw a PEX plumbing system. A hot air gun may be used as long as the temperature does not exceed 300°F (149°C). Do not use a hot air gun on one spot for more than five minutes at a time. Do not heat pipe until it changes color.

## Damaged Pipe

Do not splice PEX pipe in inaccessible locations. If a splice is necessary at a point underground, insulate the coupling and splice point to protect it from corrosion and stress. Always perform a leak and pressure test after making a splice.

## Bundling Lines

Run hot and cold lines in separate groups to avoid transferring heat between hot and cold lines.

## Inspection

Always inspect PEX pipe for damage and proper fastening prior to testing. Also, check all fitting and manifold connections. Repair or replace as needed. Pressure test the system with air or water at completion.

## Expansion Loops

PEX pipe expands and contracts approximately 1" per 100' of pipe for every

10°F change in temperature. Because of this expansion and contraction, expansion loops should be installed to compensate for these changes without damage to the plumbing system. When creating an expansion loop, make sure there is adequate space for the loop to expand and contract. Do not install the loop so it's touching studs or joists on both sides. These loops will expand when the pipe is heated and contract when the pipe cools or the building is unheated.

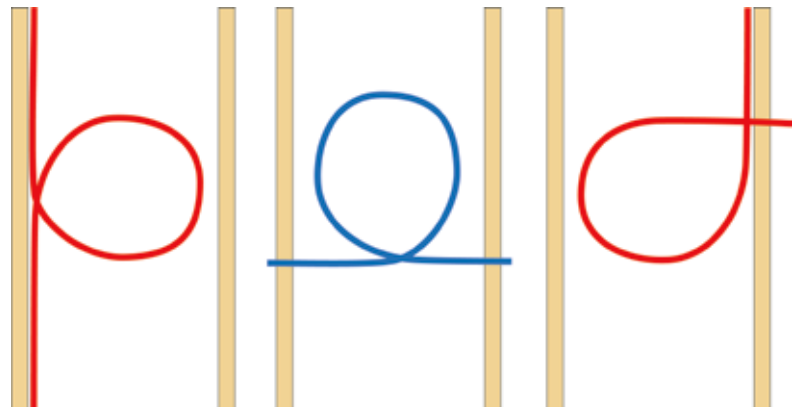

## Conventional Plumbing Method

The conventional (or trunk and branch) method has one main trunk line with smaller branch lines delivering water to various fixtures. This method uses PEX pipe with push or barb fittings and is the fastest, easiest way to get water from meter to fixtures. However, long waits for hot water often occur.

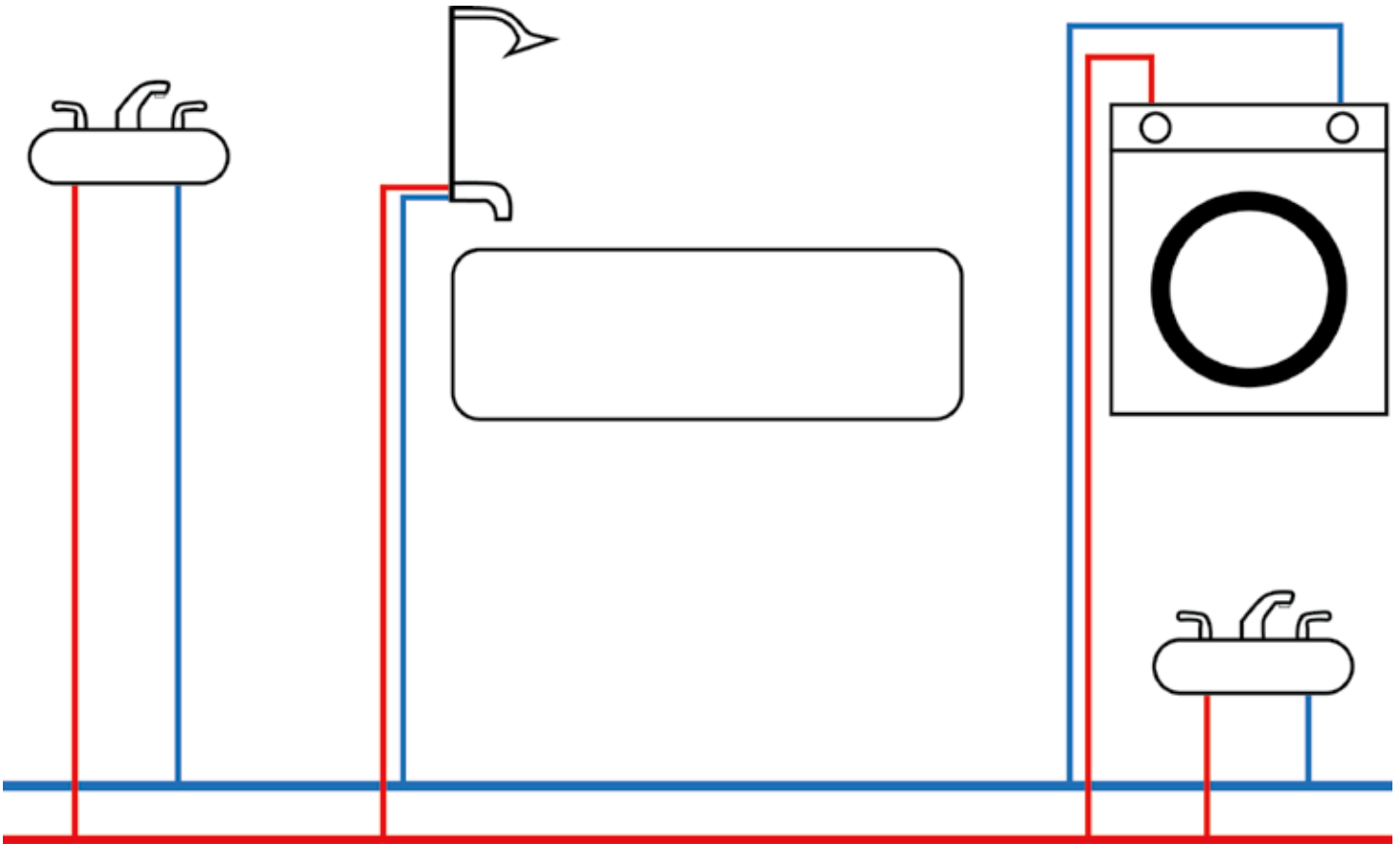

## Manifold or Home-Run Plumbing Method

The manifold or home-run plumbing method provides a distribution point to all fixtures. This method uses PEX pipe with a manifold consisting of the same number of ports as fixtures available, and push or barb fittings. Manifolds offer a variety of benefits:

- Control water at one central location.
- Faster delivery of hot water.
- Save Time and Money - Manifolds allow you to make longer continuous runs of PEX pipe, meaning you buy fewer fittings and spend less time installing.
- Fewer Possible Leaks - Longer continuous runs with fewer crimp connections means fewer chances of leaks and avoiding the possibility of thousands of dollars in water damage.
- Controls Scalding - When plumbed so that each branch line feeds only one fixture, the manifold greatly reduces pressure fluctuations and temperature swings that cause scalding.
- Quiet Plumbing - Longer runs of pipe using fewer fittings means smoother bends and turns which reduces line noise and “water hammer”.

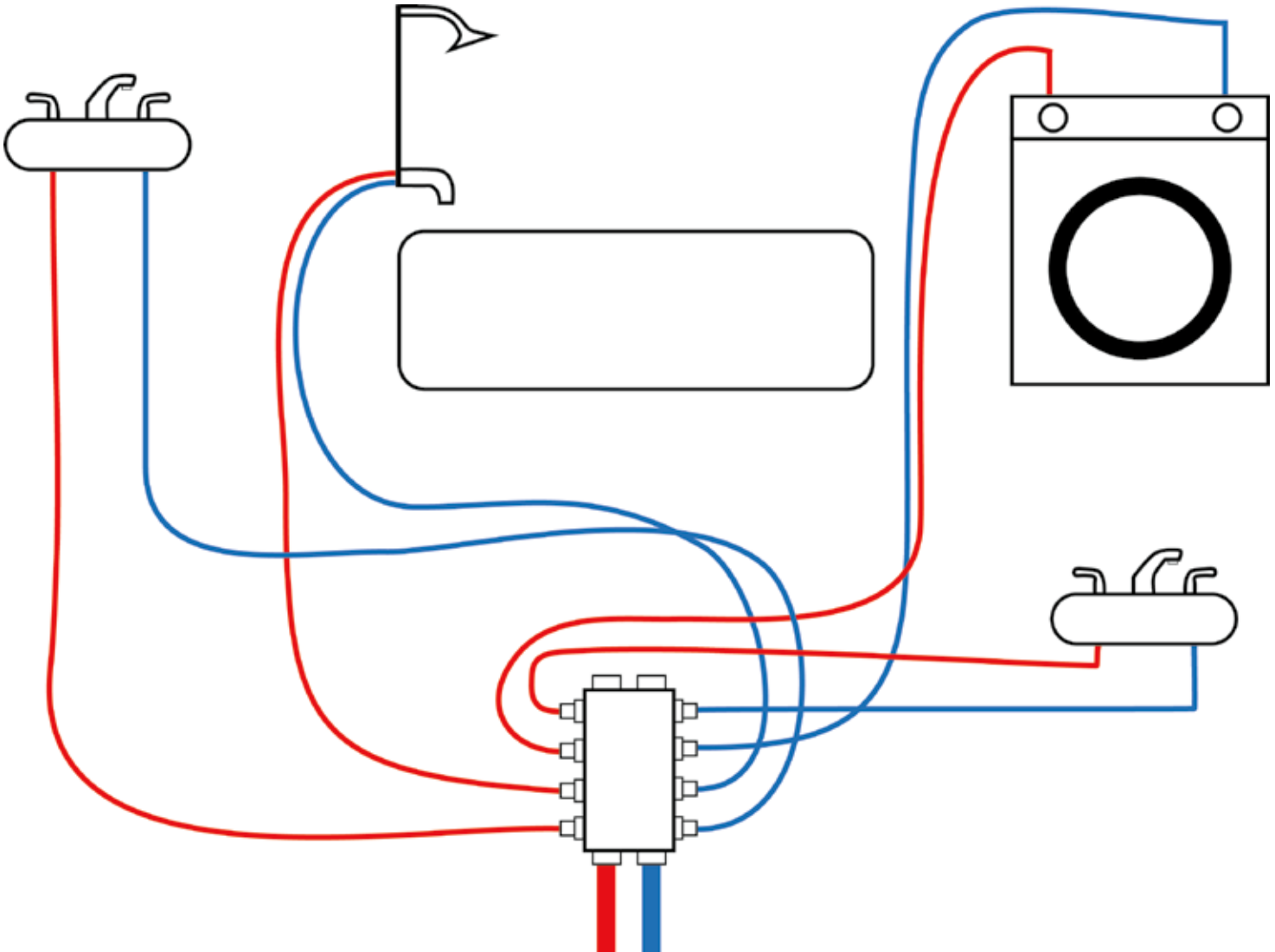

## Manifolds

Each manifold has a galvanized back plate for easy mounting to any structure. The cover plate, for labeling purposes, is constructed of 1/4" ABS. All manifolds are bolted to the back plate, rather than screwed. Each manifold consists of two inlet ports that supply the dual chambers. Typically one inlet is used for cold water supply, and the other inlet is used for hot water supply. However, both inlets may be used for either hot or cold water. The inlets are not temperature specific. The water inlets connections are 3/4" PEX Barb, The outlets are 1/2" MPT. 1/2" FPT Swivel x Barb valves are included.

Each manifold is individually boxed, and includes red and blue labels for indicating the destination fixtures. Keep the manifold in it's carton until ready for installation. Protect the manifold from dust and debris until plumbing system is fully installed.

## How To Install:

1. Count the number of cold and hot water locations in the house. Be sure to include outside hose bibs and the refrigerator ice maker.
2. Make sure the manifold has as many ports as the house has hot and cold locations.
3. Find an accessible location near the water heater, but not closer than 18" from the water heater outlet, to place the manifold.
4. Attach the shut off valves.
5. Position the manifold in the desired location and nail or screw the mounting bracket to the studs. Make sure all valve handles have room for operation.
6. Attach 1/2" PEX pipe to the inlets and outlets and crimp or clamp securely. Close and cap all unused manifold ports.
7. Label each connection to the water location it supplies. Labels are included with each manifold.



## Manifold Installation Warnings:

- Before and after installation, ensure manifold is kept in a location with limited exposure to chemicals, paint, hazardous materials, debris, excessive heat, direct flame, or moving objects that could cause damage.
- The manifold should be located in an area that will not be covered permanently with sheetrock, plywood, or paneling.
- Manifolds should not be installed or kept in a location exposed to freezing temperatures.
- Do not allow water to freeze in the manifold.
- Do not use pipe dope or tape to seal any fittings on the manifold.
- Care should be taken not to over or under tighten fittings.
- Distribution lines must connect to the connecting valves in a straight line perpendicular to the manifold as to avoid bending stress on the valves.
- Manifolds should be installed per all local and national building/plumbing codes. Where a conflict exists between installation instructions and local requirements, the local codes shall take precedence.
- The installer must also meet all qualifications required by the state and/or local administrative authority administering the provisions of the code where PEX piping is installed.
- The Mosack Group, Inc. is not responsible for leaks and property damage caused by failure to follow the installation instructions.



[www.mosackgroup.com](http://www.mosackgroup.com)

The Mosack Group, Inc.  
Mint Hill, NC 28227  
1.888.229.2874